

Centro

Inline centrifugal fans

Use

- Supply and extraction ventilation of offices, bathrooms, toilets, laundries, kitchens, ensembles in apartments, hotels, homes and commercial buildings.
- Compatible with Ø 150 up to 315 mm round air ducts.



Air flow:
up to 1700 m³/h
472 l/s



Power:
from 80 W



Noise level:
from 65 dBA



Design

- High quality durable plastic casing.
- Aerodynamically shaped casing.
- Airtight mounting box.

Motor

- 220–240 V single phase at 50 Hz.
- All motors have a sealed ball bearing motor with a service life of up to 40,000 hours.
- All motors have manual reset thermal overload protection as required for inline duct fans AS/NZS60335-2-80:2004.

Wiring

- All fans come standard with a 1.2 m lead and 2 pin plug.
- Fans can be speed controlled.

Mounting

- Due to compact design the fan is the ideal solution for mounting in limited spaces.
- Any mounting position.
- Wall or ceiling mounting with fixing brackets supplied as a standard.
- Flexible air ducts are fixed on the fan spigots.



INLINE FANS

Designation key

Series	Duct diameter [mm]	Motor modifications
Centro	150; 200; 250; 315	max: high powered motor

Ordering Information

Part Number	Model	Description
BLACENTRO150	Centro 150	INLINE FAN CENTRIFUGAL 150 mm
BLACENTRO200	Centro 200	INLINE FAN CENTRIFUGAL 200 mm
BLACENTRO250	Centro 250	INLINE FAN CENTRIFUGAL 250 mm
BLACENTRO315	Centro 315	INLINE FAN CENTRIFUGAL 315 mm
BLACENTRO315MAX	Centro 315 max	INLINE FAN CENTRIFUGAL 315 mm

Accessories

Filter box	Speed controller	Grilles and cowls	Ducting	Low profile ducting	Backdraft damper	Fire damper

Overall Dimensions [mm]

Type	∅ D	∅ D1	B	L	L1	L2	L3	Weight [kg]
Centro 150	150/160	300	310	286	30	30	30	2.45
Centro 200	200	340	354	276	30	30	40	3.00
Centro 250	250	340	354	265	30	30	40	4.30
Centro 315	315	400	414	276	40	55	40	4.85
Centro 315 max	315	400	414	276	40	55	40	4.85

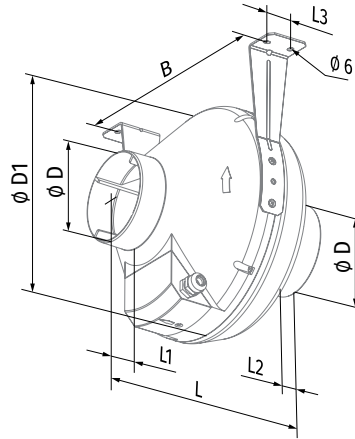

Technical Data

Parameters	Centro 150		Centro 200	
Voltage [V]	1 ~ 230		1 ~ 230	
Frequency [Hz]	50	60	50	60
Power [W]	80	84	107	132
Current [A]	0.35	0.37	0.47	0.58
Maximum air flow [m ³ /h (l/s)]	460 (128)	505 (140)	780 (217)	890 (247)
RPM [min ⁻¹]	2725	2840	2660	2765
Sound pressure at 3 m [dBA]	69	69	65	65
Max. transported air temperature [°C]	-25...+55	-25...+50	-25...+55	-25...+50
SEC class	B	-	B	-
IP rating	IPX4		IPX4	
Motor IP rating	IP44		IP44	
ErP	2018		2018	

CENTRO 150

Sound power level, A-weighted	Total	Octave frequency bands [Hz]								LpA 3 m	LpA 1 m
		63	125	250	500	1000	2000	4000	8000		
LWA to inlet [dBA]	90	53	87	86	75	74	71	68	54	69	79
LWA to outlet [dBA]	90	53	88	85	72	71	66	65	52	69	79
LWA to environment [dBA]	63	26	46	55	57	57	57	47	35	42	52

CENTRO 200

Sound power level, A-weighted	Total	Octave frequency bands [Hz]								LpA 3 m	LpA 1 m
		63	125	250	500	1000	2000	4000	8000		
LWA to inlet [dBA]	85	47	74	81	77	77	78	70	59	65	75
LWA to outlet [dBA]	83	44	73	77	75	75	78	70	60	63	73
LWA to environment [dBA]	66	27	48	59	61	61	59	51	39	46	56

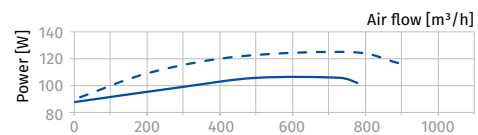
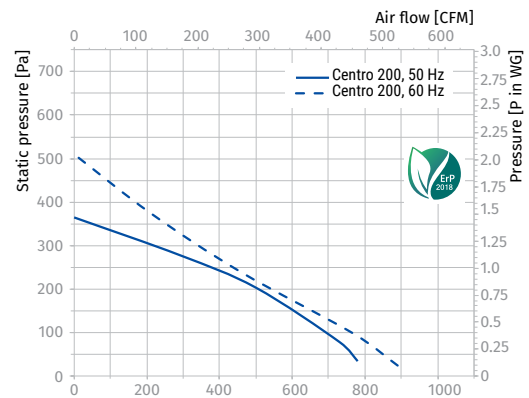
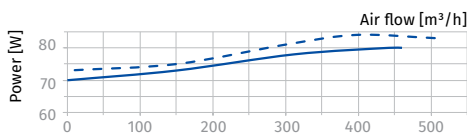
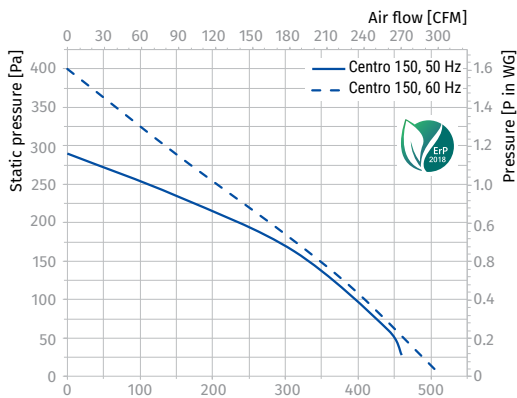

Parameters	Centro 250		Centro 315		Centro 315 max	
Voltage [V]	1 ~ 230		1 ~ 230		1 ~ 230	
Frequency [Hz]	50	60	50	50	50	
Power [W]	173	207	200	310		
Current [A]	0.76	0.9	0.88	1.36		
Maximum air flow [m³/h (l/s)]	1080 (300)	1090 (303)	1340 (372)	1700 (472)		
RPM [min ⁻¹]	2090	2120	2655	2590		
Sound pressure at 3 m [dBA]	70	70	66	73		
Max. transported air temperature [°C]	-25...+55	-25...+50	-25...+55	-25...+45		
SEC class	B	-	-	-		
IP rating	IPX4		IPX4		IPX4	
Motor IP rating	IP44		IP44		IP44	
ErP	2018		2018		2018	

CENTRO 250

Sound power level, A-weighted	Total	Octave frequency bands [Hz]								LpA 3 m	LpA 1 m
		63	125	250	500	1000	2000	4000	8000		
LWA to inlet [dBA]	90	61	78	85	83	85	81	77	65	70	80
LWA to outlet [dBA]	88	64	77	73	82	84	82	77	63	68	78
LWA to environment [dBA]	69	35	49	61	64	64	62	50	39	49	59

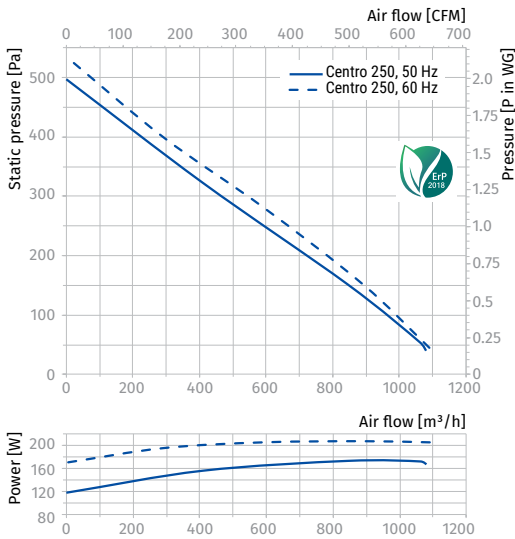

CENTRO 315, CENTRO 315 MAX

Sound power level, A-weighted	Total	Octave frequency bands [Hz]								LpA 3 m	LpA 1 m
		63	125	250	500	1000	2000	4000	8000		
Centro 315											
LWA to inlet [dBA]	86	51	73	71	75	81	82	77	68	66	76
LWA to outlet [dBA]	87	55	66	76	73	81	84	77	69	66	76
LWA to environment [dBA]	69	30	48	59	63	65	62	52	38	48	58
Centro 315 max											
LWA to inlet [dBA]	93	56	80	78	82	88	89	84	74	73	83
LWA to outlet [dBA]	93	59	72	82	79	87	90	83	75	72	82
LWA to environment [dBA]	78	33	54	63	71	73	73	63	55	57	67

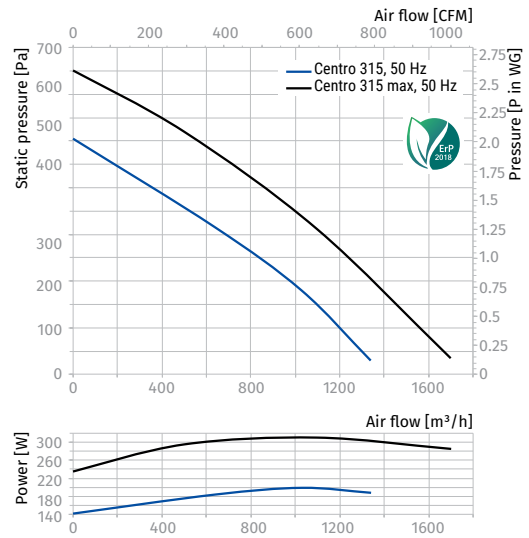

INLINE FANS